

GlobTek, Inc.  
 www.globtek.com  
 186 Veterans Drive,  
 Northvale, NJ 07647  
 Tel. (201) 784-1000  
 Fax (201) 784-0111

Drawing Title: GTM96180-1830-6.0-T2, ITE / Medical Power Supply/Class 2/Household Power Supply, Efficiency Level: VI, Case Color/Style: GlobTek Black, Desktop/External, Regulated Switchmode AC-DC Power Supply AC Adaptor, Input Rating: 100-240V~, 50-60 Hz, IEC 60320/C8 , Output Rating: 18W, 24V@0.75A, Output Configuration: 1530 mm, 18/1C + Shield Cond, UL 1185, Female Barrel 5.5 \* 2.5 \* 11mm with internal Spring Clip and Locking Notch or Equal, Ferrite: None, GlobTek Black, GT Cord # C0170, Pin Out: Center Positive (+V), Blades/Input Cord: Not Applicable, Approvals: VCCI Ukraine RoHS LPS Level VI China RoHS CE cETLus 60601-1 3rd EAC 230V CoC Tier 2 IRAM CB CB IP42 WEEE CB PSE PSE PSE cETLus UL1310 CB CE CCC Double Insulation ETL FCC CAN ICES-3 S-Mark

Model No. GTM96180-1830-6.0-T2

Part No./Ordering No. TR9KI750LCP-IMR6B

Rev C

## REVISION HISTORY

REV	DESCRIPTION	SUB	DATE	APPROVED
C	Update input configuration from IEC 60320/C14 to IEC 60320/C8 Update engineering model from GTM96180-1830-6.0-T3 to GTM96180-1830-6.0-T2	rchiu		QA
B	Update input configuration from IEC 60320/C8 to IEC 60320/C14	rchiu	07/06/2017	QA
A	Initial Release	jwam	05/02/2017	QA

In Addition to GlobTek Inc.'s renewed ISO9001:2008 - Quality Management System Certification, GlobTek Inc. is now certified to:

ISO13485:2003 - Medical Devices Quality Management System Certification  
 ISO14001:2004 - Environmental Management System Certification

ISO Certificates are available online at <http://www.globtek.com/iso-certificates/>

### Customer Approval of Specification:

Please approve, sign and send back to GlobTek so we can complete order processing.

A delay in receipt of this form will delay delivery schedule.

Company Name:

Customer P/N:

Quote Number:

Date:

Authorized Representative Name:

Authorized Representative Signature:

The acceptance of this specification and use of the product described in this document indicates the acceptance and binding of the customer to Globtek terms and conditions, which supersede all other agreements, terms, and conditions (<http://en.globtek.com/terms-and-conditions/>).

### Footnote:

GlobTek Inc. will not be liable for the safety and performance of these power supplies if unauthorized access and repair occurs. End user should consult applicable UL, CSA or EN standards for proper installation instruction.

### Limitation of Use:

GlobTek product are not authorized for use as mission critical components in life support hazardous environment, nuclear or aircraft applications without prior written approval from the CEO of GlobTek Inc.

Contents of this document are subject to change without prior notice.

GTM96180-1830-6.0-T2, 18W, 24V@0.75A, Desktop/External, Regulated Switchmode AC-DC Power Supply AC Adaptor

PROPRIETARY INFORMATION

PROPRIETARY OF GLOBTEK, INC. ANY REPRODUCTION, DISCLOSURE OR USE OF THIS DRAWING, IN WHOLE OR IN PART, IS HEREBY PROHIBITED EXCEPT AS SPECIFIED IN WRITING BY GLOBTEK, INC.

GloTek, Inc. www.globtek.com 186 Veterans Drive, Northvale, NJ 07647 Tel. (201) 784-1000 Fax (201) 784-0111	Drawing Title: GTM96180-1830-6.0-T2, ITE / Medical Power Supply/Class 2/Household Power Supply, Efficiency Level: VI, Case Color/Style: GlobTek Black, Desktop/External, Regulated Switchmode AC-DC Power Supply AC Adaptor, Input Rating: 100-240V~, 50-60 Hz, IEC 60320/C8 , Output Rating: 18W, 24V@0.75A, Output Configuration: 1530 mm, 18/1C + Shield Cond, UL 1185, Female Barrel 5.5 * 2.5 * 11mm with internal Spring Clip and Locking Notch or Equal, Ferrite: None, GlobTek Black, GT Cord # C0170, Pin Out: Center Positive (+V), Blades/Input Cord: Not Applicable, Approvals: VCCI Ukraine RoHS LPS Level VI China RoHS CE cETLus 60601-1 3rd EAC 230V CoC Tier 2 IRAM CB CB IP42 WEEE CB PSE PSE PSE cETLus UL1310 CB CE CCC Double Insulation ETL FCC CAN ICES-3 S-Mark	
	Model No. GTM96180-1830-6.0-T2	
	Part No./Ordering No. TR9KI750LCP-IMR6B	Rev C

**POWER SUPPLY INFORMATION**

TYPE: Desktop/External  
TECHNOLOGY: Regulated Switchmode AC-DC Power Supply AC Adaptor  
CASE COLOR: GlobTek Black  
NAMEPLATE RATED INPUT: 100-240V~, 50-60 Hz, 0.6 A  
INPUT CONFIG: IEC 60320/C8  
WATTS: 18.0  
VOLTS OUT: 24  
CURRENT OUT (Amps): 0.75  
BLADE/CORD INCLUDED: N/A:  
BLADE/CORD INSTALLED: N/A:  
GROUNDING CONFIGURATION (E1) Earthed output  
EFFICIENCY LEVEL: VI  
OUTPUT CONFIGURATION 1530 mm, 18/1C + Shield Cond, UL 1185, Female Barrel 5.5 \* 2.5 \* 11mm with internal Spring Clip and Locking Notch or Equal, Ferrite: None, GlobTek Black, GT Cord # C0170  
CONNECTOR PIN OUT: Center Positive (+V)  
LABEL SPECS: Standard GT,L-1186  
PACK SPEC: Standard WPI, Individually Box

Notes/Modifications/Customizations (notes in this section supersede the values shown in the standard spec):

DIMENSIONS ARE IN MM UNLESS SPECIFIED OTHERWISE.

GlobTek, Inc. www.globtek.com 186 Veterans Drive, Northvale, NJ 07647 Tel. (201) 784-1000 Fax (201) 784-0111	Drawing Title: GTM96180-1830-6.0-T2, ITE / Medical Power Supply/Class 2/Household Power Supply, Efficiency Level: VI, Case Color/Style: GlobTek Black, Desktop/External, Regulated Switchmode AC-DC Power Supply AC Adaptor, Input Rating: 100-240V~, 50-60 Hz, IEC 60320/C8 , Output Rating: 18W, 24V@0.75A, Output Configuration: 1530 mm, 18/1C + Shield Cond, UL 1185, Female Barrel 5.5 * 2.5 * 11mm with internal Spring Clip and Locking Notch or Equal, Ferrite: None, GlobTek Black, GT Cord # C0170, Pin Out: Center Positive (+V), Blades/Input Cord: Not Applicable, Approvals: VCCI Ukraine RoHS LPS Level VI China RoHS CE cETLus 60601-1 3rd EAC 230V CoC Tier 2 IRAM CB CB IP42 WEEE CB PSE PSE PSE cETLus UL1310 CB CE CCC Double Insulation ETL FCC CAN ICES-3 S-Mark	
	Model No. GTM96180-1830-6.0-T2	
	Part No./Ordering No. TR9KI750LCP-IMR6B	Rev C

## ELECTRICAL SPECIFICATIONS

### A) ELECTRICAL SPECIFICATIONS:

01. Input Voltage: Specified 90-264 Vac, Nameplate rated: 100-240Vac
  - 90-264 Vac range @ 100% of rated load current
  - 85-264 Vac range @ 85% of rated load current
  - 110-370 VDC range @ 100% of rated load current
02. Input Frequency: Specified 47-63 Hz, Nameplate rated 50-60Hz
03. Output Regulation: +/- 5% measured at the output connector
04. Line Voltage Regulation: +/- 0.5% typical measured at full load
05. Green Power On Indicator LED
06. Output Ripple (Vp-p): 1% or 100 mV whichever is greater, measured at 20 MHz bandwidth with 0.1 uf ceramic capacitor in parallel with a low impedance 47 uf electrolytic capacitor connected at the end of the output connector
07. Turn-ON/OFF Overshoot: 5% maximum, 1 mS typical recovery time for 40% to 70% step load
08. Turn-ON Delay: 1 second maximum @ full load, nominal line
09. Hold-Up Time: 8 mS typical @ nominal input voltage and full load
10. Inrush Current: 30A/60A maximum cold start @ 115/230Vac input
11. Efficiency: Compliant with Efficiency Level VI and CoC Tier 2 standards
12. No Load Standby Power: <0.075 W @ 230Vac

### B) PROTECTION

01. Input Protection: Input line fusing and 300Vac MOV
02. Short Circuit/ Overload: Electronically Protected unit will auto recover upon removal of fault
  - Output Current Limit: 110% to 160% of rated output current
  - (upper end of current limit range is determined by normal output power rating, not derated output power level)
03. Output Over-Voltage: 110% to 130% of nominal output voltage

### C) SAFETY

01. Dielectric Withstand Voltage: 4000Vac or 5656Vdc from input to output, On Class I models, 3000Vac or 4242Vdc from input to earth
02. Earth Leakage Current: Class I models < 300uA, N/A for Class II models
03. Touch Current: Class I models < 20uA, Class II models < 75uA
04. Output Floating or Earthed option for Class I desktop models.
  - See [Output Isolation Options](#) for details
05. Earth Continuity Test: < 0.1 Ohm between Earth Pin at AC input and PCB termination point (Class I models only)
06. Means of Protection: 2 x MOPP
07. Compliant Standards: See listings at end of this drawing for specifics

### D) EMC

- EN 60601-1-2, 4<sup>th</sup> edition
- Emissions, per EN 55032, EN 61000-6-3, EN 61000-6-4
- Conducted Emissions: Class B, FCC Part 15, Class B
  - Radiated Emissions: Class B, FCC Part 15, Class B
- Line Frequency Harmonics EN61000-3-2, Class A
- Voltage Fluctuations/Flicker EN61000-3-3

- Immunity, per EN 55024, EN 61000-6-1, EN 61000-6-2
- Static Discharge Immunity EN61000-4-2, 10kV Contact Discharge, 20kV air discharge
  - Radiated RF Immunity EN61000-4-3, 10V/m 80-1000MHz, 3V/m 1-2.7GHz, 80% 1KHz AM.
  - EFT/Burst Immunity EN61000-4-4, 4kV/100kHz.
  - Line Surge Immunity EN61000-4-5, 2kV differential, 4kV common-mode
  - Conducted RF Immunity EN61000-4-6, 3Vrms, 80% 1KHz AM
  - Power Frequency Magnetic Field Immunity EN61000-4-8, 3A/m
  - Voltage Dip Immunity EN61000-4-11, Criteria

### E) OTHER:

01. MTBF: 1,000,000 Hours @ 40°C ambient temperature, Full Load
02. Operating Temperature: -20°C to 40°C ambient temperature at full load, -40°C to 50°C ambient temperature with derating to 80% load
03. Operating Humidity: 0% to 95% relative humidity, non-condensing
04. Storage Temperature: -30°C to 80°C
05. Operating Altitude: 5000 Meters

#### PROPRIETARY INFORMATION

PROPRIETARY OF GLOBTEK, INC. ANY REPRODUCTION, DISCLOSURE OR USE OF THIS DRAWING, IN WHOLE OR IN PART, IS HEREBY PROHIBITED EXCEPT AS SPECIFIED IN WRITING BY GLOBTEK, INC.

quest /08/20/2018 7:42:38 AM

GlobTek, Inc.  
 www.globtek.com  
 186 Veterans Drive,  
 Northvale, NJ 07647  
 Tel. (201) 784-1000  
 Fax (201) 784-0111

Drawing Title: GTM96180-1830-6.0-T2, ITE / Medical Power Supply/Class 2/Household Power Supply, Efficiency Level: VI, Case Color/Style: GlobTek Black, Desktop/External, Regulated Switchmode AC-DC Power Supply AC Adaptor, Input Rating: 100-240V~, 50-60 Hz, IEC 60320/C8 , Output Rating: 18W, 24V@0.75A, Output Configuration: 1530 mm, 18/1C + Shield Cond, UL 1185, Female Barrel 5.5 \* 2.5 \* 11mm with internal Spring Clip and Locking Notch or Equal, Ferrite: None, GlobTek Black, GT Cord # C0170, Pin Out: Center Positive (+V), Blades/Input Cord: Not Applicable, Approvals: VCCI Ukraine RoHS LPS Level VI China RoHS CE cETLus 60601-1 3rd EAC 230V CoC Tier 2 IRAM CB CB IP42 WEEE CB PSE PSE PSE cETLus UL1310 CB CE CCC Double Insulation ETL FCC CAN ICES-3 S-Mark

Model No. GTM96180-1830-6.0-T2

Part No./Ordering No. TR9KI750LCP-IMR6B

Rev C

- 06. Ingress Protection: IP40 standard, IP52 available as special option
- 07. ROHS: Compliant with latest regulations, see approvals section below

F) ENCLOSURE

- 01. Housing: High impact plastic, 94V0 polycarbonate, non-vented
- 02. Markings: Label or Laser Printed
- 03. AC Input mechanical options: Class II Wall Plug-in, Changeable Blades Desktop Option, extended housing: C6, C8, C14 or C18 IEC Inlet.

G) SPECIAL OPTIONS

- 01. Cost reduction, removal of LED
  - 02. Custom Cordsets, various cordage types, and connector types\*
  - 03. Custom Markings
  - 04. Short term Output Surge Capability
  - 05. Reduced Leakage Current versions (10uA max), for CF medical applications, and AC noise sensitive equipment, 15W or less, 5V to 24V output voltage range.
  - 06. Tightened output voltage tolerance
  - 07. Reduced output ripple level
  - 08. Reduced output power rating marking
  - 09. High Rel PCB laminate with Plated through Holes for IPC610 Class 2 Compliance
  - 10. Special Housing Colors and Cordset Colors
  - 11. Quasi Constant Current Output, for Lead-Acid Battery Charger Applications
- \* 5Vdc USB output connector power supplies, which use the Micro-B or C-type style connector, have a max output voltage regulation specification of +/-8% (4.6V to 5.4V range).

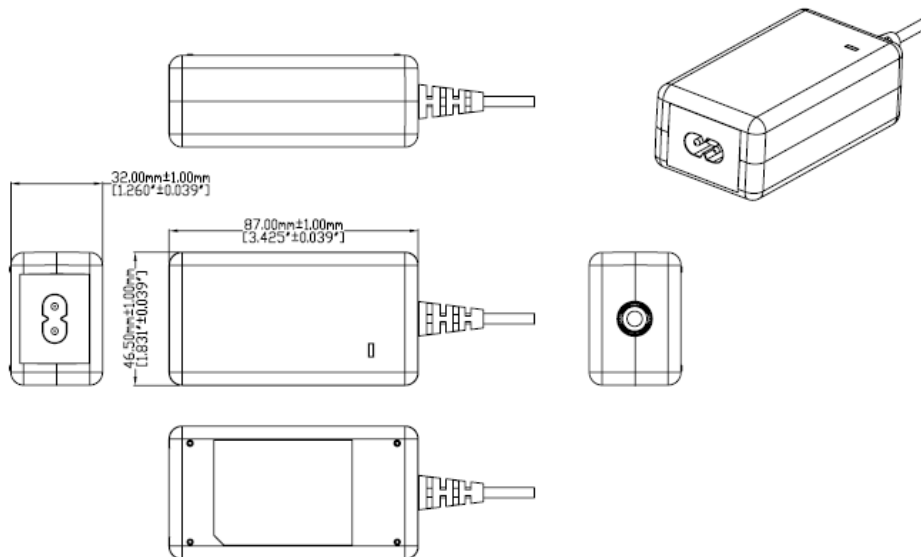

DERATING CURVE

GlobTek, Inc.  
www.globtek.com  
186 Veterans Drive,  
Northvale, NJ 07647  
Tel. (201) 784-1000  
Fax (201) 784-0111

Drawing Title: GTM96180-1830-6.0-T2, ITE / Medical Power Supply/Class 2/Household Power Supply, Efficiency Level: VI,  
Case Color/Style: GlobTek Black, Desktop/External, Regulated Switchmode AC-DC Power Supply AC Adaptor, Input Rating:  
100-240V~, 50-60 Hz, IEC 60320/C8 , Output Rating: 18W, 24V@0.75A, Output Configuration: 1530 mm, 18/1C + Shield  
Cond, UL 1185, Female Barrel 5.5 \* 2.5 \* 11mm with internal Spring Clip and Locking Notch or Equal, Ferrite: None, GlobTek  
Black, GT Cord # C0170, Pin Out: Center Positive (+V), Blades/Input Cord: Not Applicable, Approvals: VCCI Ukraine RoHS  
LPS Level VI China RoHS CE cETLus 60601-1 3rd EAC 230V CoC Tier 2 IRAM CB CB IP42 WEEE CB PSE PSE PSE  
cETLus UL1310 CB CE CCC Double Insulation ETL FCC CAN ICES-3 S-Mark

Model No. GTM96180-1830-6.0-T2

Part No./Ordering No. TR9KI750LCP-IMR6B

Rev C

### TYPICAL EXTERNAL POWER SUPPLY DERATING CURVE

(FOR 18W AND 36W EFFICIENCY LEVEL VI PRODUCTS)

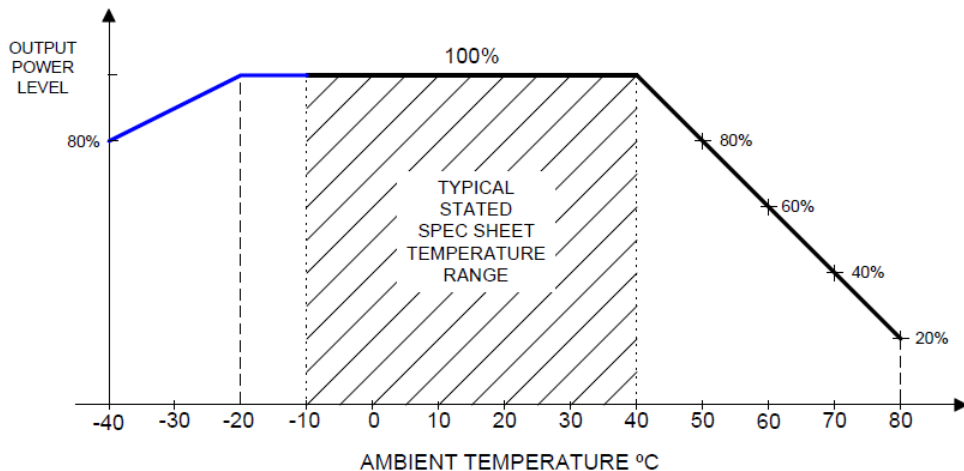

GlobTek, Inc.  
 www.globtek.com  
 186 Veterans Drive,  
 Northvale, NJ 07647  
 Tel. (201) 784-1000  
 Fax (201) 784-0111

Drawing Title: GTM96180-1830-6.0-T2, ITE / Medical Power Supply/Class 2/Household Power Supply, Efficiency Level: VI, Case Color/Style: GlobTek Black, Desktop/External, Regulated Switchmode AC-DC Power Supply AC Adaptor, Input Rating: 100-240V~, 50-60 Hz, IEC 60320/C8 , Output Rating: 18W, 24V@0.75A, Output Configuration: 1530 mm, 18/1C + Shield Cond, UL 1185, Female Barrel 5.5 \* 2.5 \* 11mm with internal Spring Clip and Locking Notch or Equal, Ferrite: None, GlobTek Black, GT Cord # C0170, Pin Out: Center Positive (+V), Blades/Input Cord: Not Applicable, Approvals: VCCI Ukraine RoHS LPS Level VI China RoHS CE cETLus 60601-1 3rd EAC 230V CoC Tier 2 IRAM CB CB IP42 WEEE CB PSE PSE PSE cETLus UL1310 CB CE CCC Double Insulation ETL FCC CAN ICES-3 S-Mark

Model No. GTM96180-1830-6.0-T2

Part No./Ordering No. TR9KI750LCP-IMR6B

Rev C

### INPUT CONFIGURATION

Grounding Configuration:

Blades/Cord Included: N/A:

Blades/Cord Installed: N/A:

IEC 60320/C8 AC Inlet connector, Class II, Non-Earth Ground (aka "Figure-8")

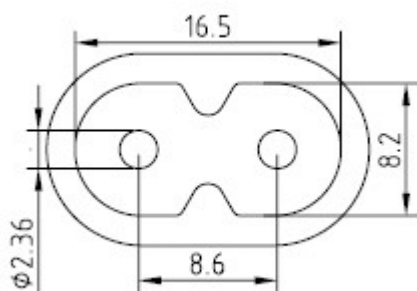

Mates with IEC 60320/C7 Plug

#### [Standard International IEC 320/C7 Cordsets](#)

Below are standard cordsets which are "not included" (unless stated above); these may be purchased separately or packaged with the power supply. Please contact your Sales Engineer if the style required is not shown below. Many more available in different lengths, colors or cable material.

Conductors (No Ground) IEC 320/C7 (Figure "8")

Part No	Country	End A	End B	Length
<a href="#">4511116F703A(R)</a>	N. American	NEMA 1-15P	IEC 320/C7	1830
<a href="#">5014112M703A(R)</a>	Australian	AS 3112	IEC 320/C7	2000
<a href="#">4533501M8703(R)</a>	China	GB 2099.1	IEC 320/C7	1830
<a href="#">204B4222M703(R)</a>	Brazil	Brazil NBR 6147	IEC 320/C7	2000
<a href="#">2074112M703A(R)</a>	European	CEE 7/16	IEC 320/C7	2000
<a href="#">451J3401M8703(R)</a>	Japan	JIS 8303	IEC 320/C7	1830
<a href="#">2044112M703A(R)</a>	Korea	KS C 8305	IEC 320/C7	2000
<a href="#">4033401M8703A(R)</a>	Taiwan	CNS 10917	IEC 320/C7	1800
<a href="#">6104112M703A(R)</a>	UK	BS1363	IEC 320/C7	2000

GlobTek, Inc.  
 www.globtek.com  
 186 Veterans Drive,  
 Northvale, NJ 07647  
 Tel. (201) 784-1000  
 Fax (201) 784-0111

Drawing Title: GTM96180-1830-6.0-T2, ITE / Medical Power Supply/Class 2/Household Power Supply, Efficiency Level: VI, Case Color/Style: GlobTek Black, Desktop/External, Regulated Switchmode AC-DC Power Supply AC Adaptor, Input Rating: 100-240V~, 50-60 Hz, IEC 60320/C8 , Output Rating: 18W, 24V@0.75A, Output Configuration: 1530 mm, 18/1C + Shield Cond, UL 1185, Female Barrel 5.5 \* 2.5 \* 11mm with internal Spring Clip and Locking Notch or Equal, Ferrite: None, GlobTek Black, GT Cord # C0170, Pin Out: Center Positive (+V), Blades/Input Cord: Not Applicable, Approvals: VCCI Ukraine RoHS LPS Level VI China RoHS CE cETLus 60601-1 3rd EAC 230V CoC Tier 2 IRAM CB CB IP42 WEEE CB PSE PSE PSE cETLus UL1310 CB CE CCC Double Insulation ETL FCC CAN ICES-3 S-Mark

Model No. GTM96180-1830-6.0-T2

Part No./Ordering No. TR9KI750LCP-IMR6B

Rev C

**OUTPUT CORD AND CONNECTOR: LCL/C0170**

ACTUAL CONNECTORS, OVERMOLDS, FERRITES MAY VARY SLIGHTLY FROM THE PICTURE BELOW

CABLE TYPE	UL 1185
CABLE LENGTH (mm)	1530
CABLE TOLERANCE (mm)	+150-0
WIRE GAUGE (AWG)	18
CONDUCTORS	1C + Shield
HANK DIMENSION (mm)	80 ± 10
CABLE / CONNECTOR OVERMOLD COLOR	GlobTek Black
FERRITE TYPE / DIMENSION	None
FERRITE # OF TURNS ( <a href="#">Definition</a> )	N/A
FERRITE DIMENSION FROM STRAIN RELIEF	N/A
FERRITE DIMENSION FROM PLUG	N/A
PLUG TYPE	Female Barrel 5.5 * 2.5 * 11mm with internal Spring Clip and Locking Notch or Equal
OVER MOLD ORIENTATION	Straight
CONNECTOR PIN OUT:	Center Positive (+V)
ADDITIONAL REQUIREMENTS	 

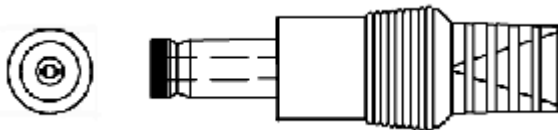

ADDITIONAL OUTPUT PLUG OPTIONS ARE AVAILABLE AT <http://www.globtek.com/connectors/>  
 STANDARD PLUGS AND CONNECTORS CAN BE SEEN ONLINE AT <http://www.globtek.com/connectors/>

GlobTek, Inc.  
 www.globtek.com  
 186 Veterans Drive,  
 Northvale, NJ 07647  
 Tel. (201) 784-1000  
 Fax (201) 784-0111

Drawing Title: GTM96180-1830-6.0-T2, ITE / Medical Power Supply/Class 2/Household Power Supply, Efficiency Level: VI, Case Color/Style: GlobTek Black, Desktop/External, Regulated Switchmode AC-DC Power Supply AC Adaptor, Input Rating: 100-240V~, 50-60 Hz, IEC 60320/C8, Output Rating: 18W, 24V@0.75A, Output Configuration: 1530 mm, 18/1C + Shield Cond, UL 1185, Female Barrel 5.5 \* 2.5 \* 11mm with internal Spring Clip and Locking Notch or Equal, Ferrite: None, GlobTek Black, GT Cord # C0170, Pin Out: Center Positive (+V), Blades/Input Cord: Not Applicable, Approvals: VCCI Ukraine RoHS LPS Level VI China RoHS CE cETLus 60601-1 3rd EAC 230V CoC Tier 2 IRAM CB CB IP42 WEEE CB PSE PSE PSE cETLus UL1310 CB CE CCC Double Insulation ETL FCC CAN ICES-3 S-Mark

Model No. GTM96180-1830-6.0-T2

Part No./Ordering No. TR9KI750LCP-IMR6B

Rev C

**LABEL:L-1186**

LABEL P/N: Standard GT  
 MATERIAL: Flat Thermal Transfer, Imprintable, Polyester Label and/or Pad Printed and/or Molded, and/or Laser Engraved in the case  
 BACKGROUND COLOR: Black if housing is Black, White or Silver if housing is White or Gray.  
 TEXT COLOR: White or Silver if label is Black Background for Black housing. Black if label is White or Silver background and Housing is White or Gray  
 LABEL WIDTH (mm): 36.5  
 LABEL HEIGHT (mm): 48.5

Below is the minimum information which will appear on the label. NOTE: in the logo area additional/actual positioning of symbols and text is subjected to change as per agency updates/requirements or additional model approvals become available. Regulatory certifications/label markings may be in logo area on the label or molded into the case housing outside the label area. Information will be shown via label and/or pad printed and/or molded and/or laser engraved in the case. \* Date code markings at GlobTek option.

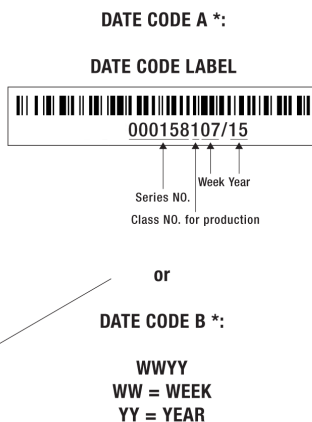

A=ITE / Medical Power Supply/Class 2/Household Power Supply  
 B=P/N: (料号) TR9KI750LCP-IMR6B  
 C=Model (型号) GTM96180-1830-6.0-T2  
 D=Input (输入) 100-240V~, 50-60 Hz, 0.6 A  
 E=Output (输出)24 V 0.75 A ,18.0W

- AGENCY ONLINE DOCUMENTS <http://www.globtek.info/certs/GTM96180-TZ/>
- CE EC-Declaration for Medical [http://www.globtek.com/pdf/ec\\_declaration/a0Oa000000O1z12EAD](http://www.globtek.com/pdf/ec_declaration/a0Oa000000O1z12EAD)
- CE EC-Declaration for Industrial/Commercial/ITE [http://www.globtek.com/pdf/ec\\_declaration/a0Oa000000O1z12EAD](http://www.globtek.com/pdf/ec_declaration/a0Oa000000O1z12EAD)
- RoHS/RoHS2 Declaration [http://www.globtek.com/pdf/rohs\\_cert/01ta0000007dRJVAA2](http://www.globtek.com/pdf/rohs_cert/01ta0000007dRJVAA2)
- REACH Declaration [http://www.globtek.com/pdf/iso\\_certificates/REACH.pdf](http://www.globtek.com/pdf/iso_certificates/REACH.pdf)



GlobTek, Inc.  
www.globtek.com  
186 Veterans Drive,  
Northvale, NJ 07647  
Tel. (201) 784-1000  
Fax (201) 784-0111

Drawing Title: GTM96180-1830-6.0-T2, ITE / Medical Power Supply/Class 2/Household Power Supply, Efficiency Level: VI, Case Color/Style: GlobTek Black, Desktop/External, Regulated Switchmode AC-DC Power Supply AC Adaptor, Input Rating: 100-240V~, 50-60 Hz, IEC 60320/C8 , Output Rating: 18W, 24V@0.75A, Output Configuration: 1530 mm, 18/1C + Shield Cond, UL 1185, Female Barrel 5.5 \* 2.5 \* 11mm with internal Spring Clip and Locking Notch or Equal, Ferrite: None, GlobTek Black, GT Cord # C0170, Pin Out: Center Positive (+V), Blades/Input Cord: Not Applicable, Approvals: VCCI Ukraine RoHS LPS Level VI China RoHS CE cETLus 60601-1 3rd EAC 230V CoC Tier 2 IRAM CB CB IP42 WEEE CB PSE PSE PSE cETLus UL1310 CB CE CCC Double Insulation ETL FCC CAN ICES-3 S-Mark

Model No. GTM96180-1830-6.0-T2

Part No./Ordering No. TR9KI750LCP-IMR6B

Rev C

Conflict Minerals Declaration

<http://www.globtek.com/pdf/conflict-minerals.pdf>

IPXY rating is based on 3rd party testing and customers should check suitability and test system level IPXY rating before ordering.

## Regulatory Certifications/Label Markings

LATEST PRODUCT/MODEL CERTIFICATIONS: <http://en.globtek.com/datasheet/id/a00a0000000lz12>

AGENCY ONLINE DOCUMENTS: <http://www.globtek.info/certs/GTM96180-TZ/>

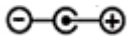

Center Positive (+V)

GlobTek, Inc.  
www.globtek.com  
186 Veterans Drive,  
Northvale, NJ 07647  
Tel. (201) 784-1000  
Fax (201) 784-0111

Drawing Title: GTM96180-1830-6.0-T2, ITE / Medical Power Supply/Class 2/Household Power Supply, Efficiency Level: VI, Case Color/Style: GlobTek Black, Desktop/External, Regulated Switchmode AC-DC Power Supply AC Adaptor, Input Rating: 100-240V~, 50-60 Hz, IEC 60320/C8 , Output Rating: 18W, 24V@0.75A, Output Configuration: 1530 mm, 18/1C + Shield Cond, UL 1185, Female Barrel 5.5 \* 2.5 \* 11mm with internal Spring Clip and Locking Notch or Equal, Ferrite: None, GlobTek Black, GT Cord # C0170, Pin Out: Center Positive (+V), Blades/Input Cord: Not Applicable, Approvals: VCCI Ukraine RoHS LPS Level VI China RoHS CE cETLus 60601-1 3rd EAC 230V CoC Tier 2 IRAM CB CB IP42 WEEE CB PSE PSE PSE cETLus UL1310 CB CE CCC Double Insulation ETL FCC CAN ICES-3 S-Mark

Model No. GTM96180-1830-6.0-T2

Part No./Ordering No. TR9KI750LCP-IMR6B

Rev C

## PACKAGING

Packing Spec P/N: Standard WPI, Individually  
Box

Box Qty: 60

Gift Box Size (mm): Egg Crate

Gift Box Color: White

Master Carton Size (mm): 480\*450\*205

Master GW (Kg): 15.2 kg

BLADES INCLUDED: N/A:

BLADE/CORD INSTALLED: N/A:

If specific packaging is required, this section must specify all requirements and note "no exceptions". If this section does not specify packaging, it is subject to change without notice at GlobTek's discretion

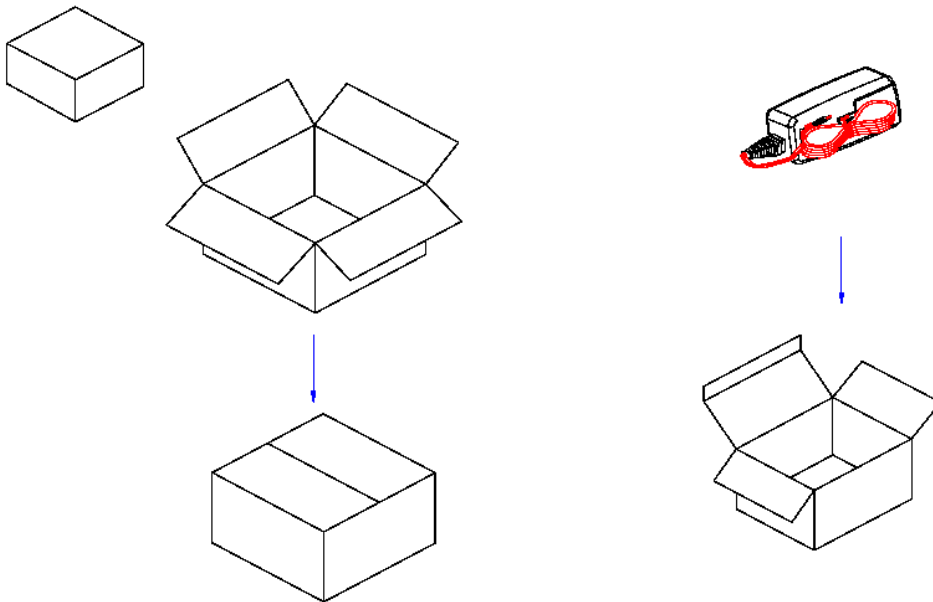

GlobTek, Inc.  
www.globtek.com  
186 Veterans Drive,  
Northvale, NJ 07647  
Tel. (201) 784-1000  
Fax (201) 784-0111

Drawing Title: GTM96180-1830-6.0-T2, ITE / Medical Power Supply/Class 2/Household Power Supply, Efficiency Level: VI, Case Color/Style: GlobTek Black, Desktop/External, Regulated Switchmode AC-DC Power Supply AC Adaptor, Input Rating: 100-240V~, 50-60 Hz, IEC 60320/C8 , Output Rating: 18W, 24V@0.75A, Output Configuration: 1530 mm, 18/1C + Shield Cond, UL 1185, Female Barrel 5.5 \* 2.5 \* 11mm with internal Spring Clip and Locking Notch or Equal, Ferrite: None, GlobTek Black, GT Cord # C0170, Pin Out: Center Positive (+V), Blades/Input Cord: Not Applicable, Approvals: VCCI Ukraine RoHS LPS Level VI China RoHS CE cETLus 60601-1 3rd EAC 230V CoC Tier 2 IRAM CB CB IP42 WEEE CB PSE PSE PSE cETLus UL1310 CB CE CCC Double Insulation ETL FCC CAN ICES-3 S-Mark

Model No. GTM96180-1830-6.0-T2

Part No./Ordering No. TR9KI750LCP-IMR6B

Rev C

## INSTRUCTION SHEET